

ALUMINUM & PVC UNITED FRAME

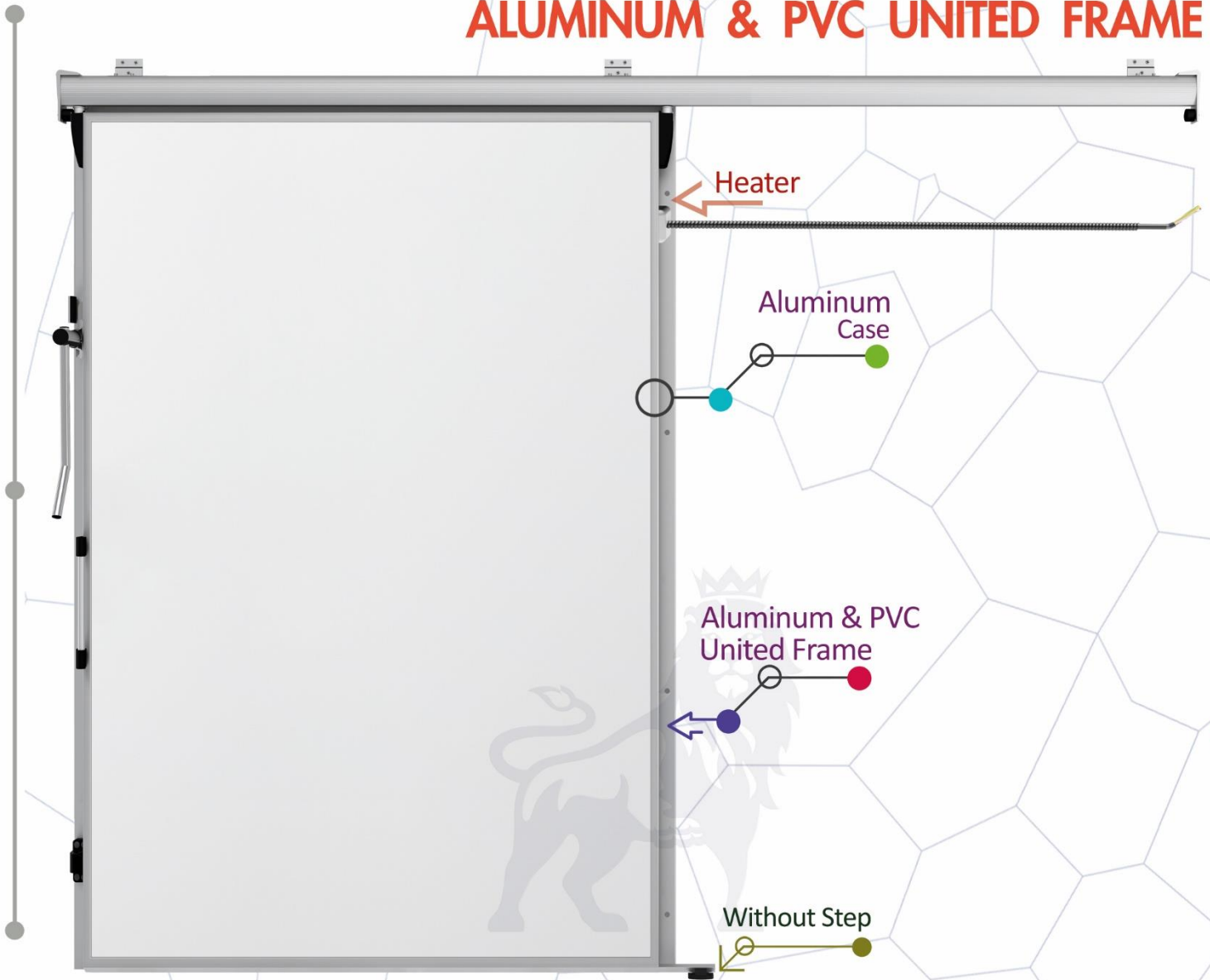

COLD ROOM DOOR & ACCESSORIES Sliding Doors



inovarefrigeration
by INOVA YAPI

INOVA REFRIGERATION DOOR AND ACCESSORIES

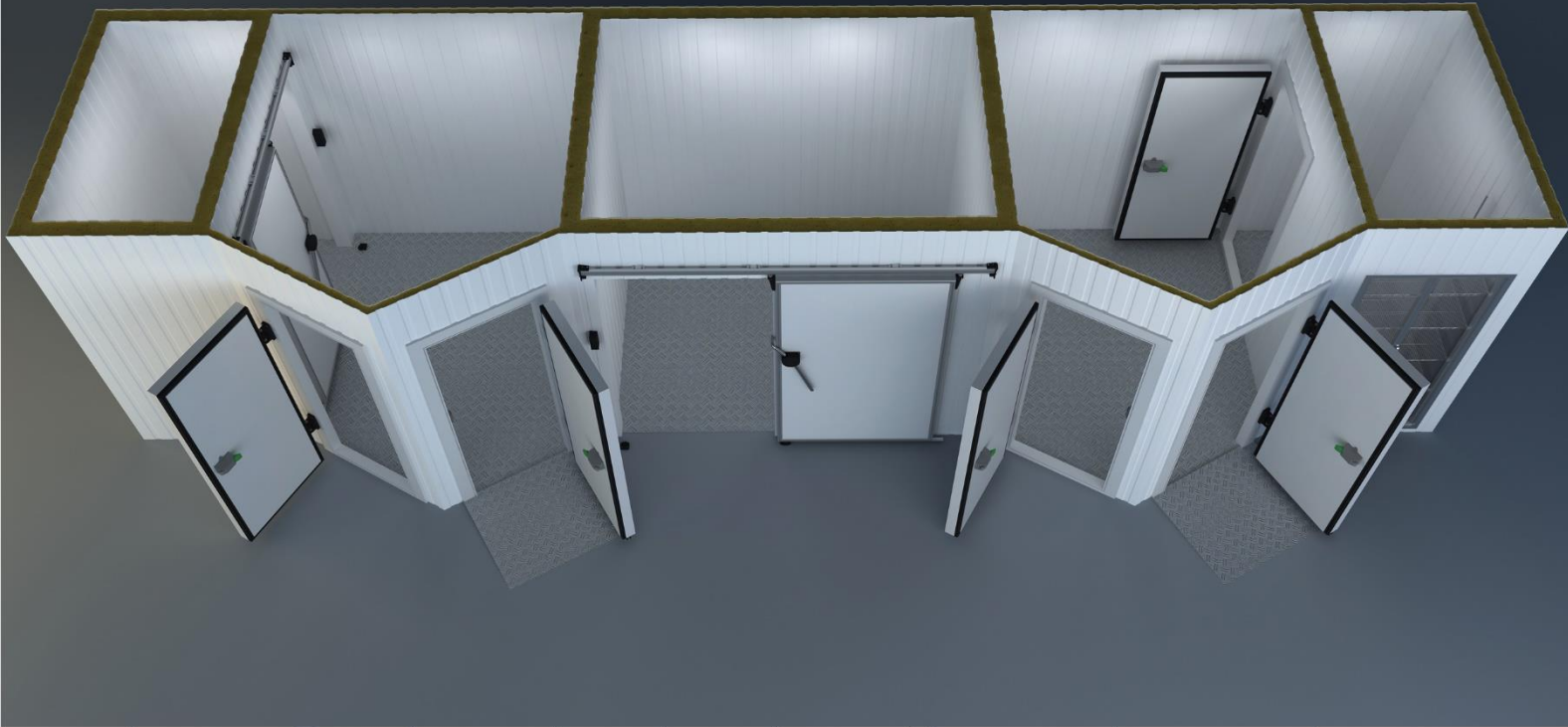

Inova Group :

Since its inception, it has Reached More Than 10,000 Customers Worldwide & We Manufactured Than More 80,000 Doors.

Our Production of Turkey :

Sliding Door With Personal Door , Folding Service Door , Double Wings of Sliding Door & With These Doors We Manufactured Hinged Door , Sliding Door ,FlipFlap Door ,Service Door & Monorail System INOVA GROUP Aims to Keep Customer Satisfaction at Maximum Level With its Quality & Service Import – Export – Production – Marketing - Sales & After - Sales Services Constitute Our Main Activity Structure .

IF YOU GIVE IMPORTANCE TO CUSTOMER YOU WILL BE THE MOST VALUABLE BRAND OF WORLD..

Inova Group Continues to Action With This Mission.

INOVA DOOR AND ACCESSORIES SYSTEMS

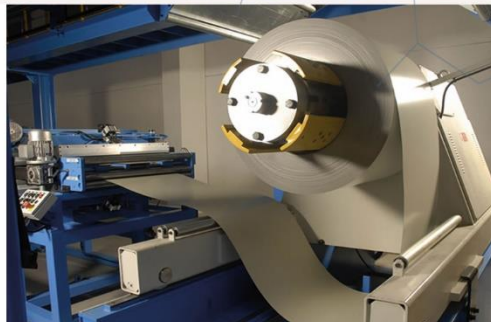
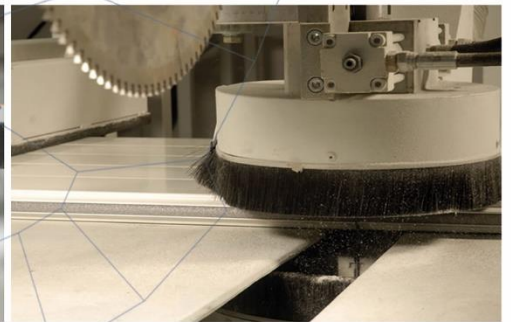
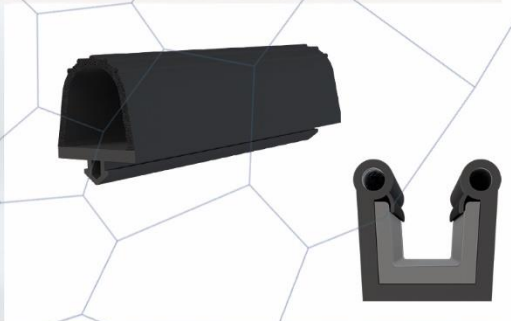
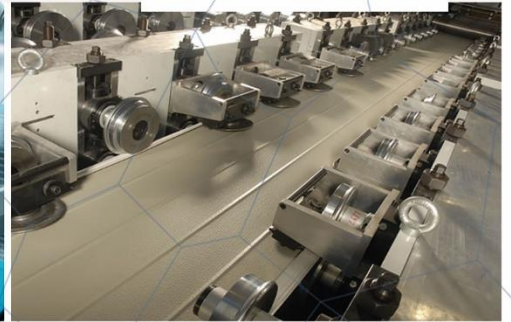
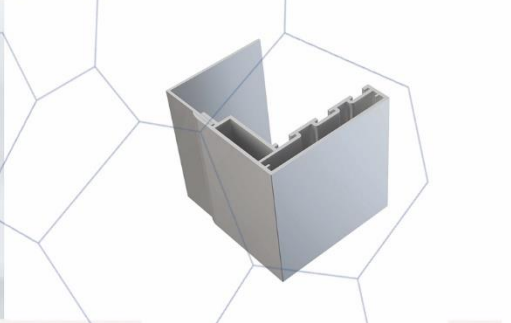
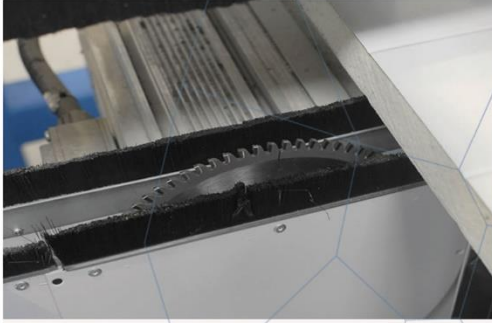
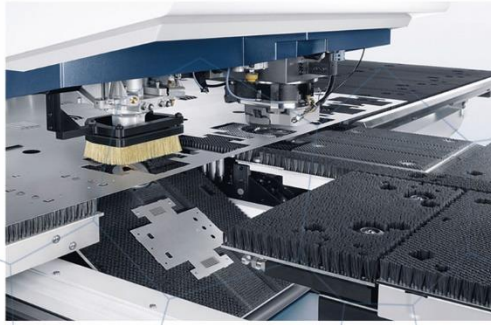

inovarefrigeration
by INOVA YAPI



THE DOORS WITH INSULATING, FILLED WITH POLYURETHANE, ISOTHERMIC - HINGED AND SLIDING DOORS-TWO LEAVES SLIDING DOORS- SLIDING DOORS WITH PERSONAL DOOR MONORAIL TYPE DOORS USAGE AREAS;



- Cold storage
- Cold rooms
- Modular cold plants
- Walk-in freezer rooms
- Vehicles with cold dorse
- Cold product protection rooms
- Shock freezing chambers
- Climating rooms
- Medical materials and waste plants
- The facilities that apply polyurethane
- Factories
- Health and beauty facilities
- Hotels
- Hospitals
- Restaurants
- Chemical laboratories
- Gsm
- Telecominication
- Morgues
- Operation rooms
- Units in which insulation and hygiene are required

Usage areas :

Cold storage , Cold rooms ; Product freezing rooms , Shock production chambers , Hotels , Medicine Storage rooms , Medical materials & Waste plants , Air conditioning rooms , Food facilities such as meat , Cheese, Milk Production facilities, Warehouses, Factories, Painthouses, Women's health & beauty centers , Garbage processing plants , Morgues , Frigolu vehicles , Telecommunication base station centers , Hygiene areas , Restaurants Food production facilities, Pastries , Hot rooms , Gsm booths , Integrated production facilities , Pc server rooms, Vegetable & fruit processing plants, Pickles Tomato Paste production facilities , Hospitals , Operating theaters , Fish production & processing plants , Clearing stations , Chemical laboratories .

Doors Special Solutions :

- Doors are easy & fast to mounted & easy to maintain
- The area to be used is produced according to your needs
- Includes special accessories developed according to every need
- It has a system to be installed according to each wall type
- It has the feature of keeping the thermal insulation at maximum level
- We use Package with strength packaging system
- Sliding type doors are produced from heat bridged profiles.maximizes

Environment and User Friendly :

- Clean design
- Does not contain bacteria
- Corrosion resistant
- High-pressure accessories
- Manufacturing with environmentally friendly products
- Maximum energy saving
- Durable materials
- High vapor proof sealing system
- Quiet and smooth operation

Dimensions of Standard Model Doors :

In general, sliding door models are not standard in the world.

Minimum and Maximum Door Dimensions :

- Minimum : 100 cm Width * 100 cm High * 80 mm thickness (wing / blade size)
- Maximum : 300 cm Width * 500 cm High * 80 mm thickness (wing / blade size)
- Maximum : 500 cm Width * 300 cm High * 80 mm thickness (wing / blade size)

Maximum door dimensions can be made by considering the international transportation standards.
Measures can be made in the desired size in the areas to be applied on-site.
Maximum dimensions can be increased for Opentop containers and truck transport



TECHNICAL SPECIFICATIONS OF DOORS :

- Room temperature range door to use** : NEGATIVE- 50C / POSITIVE 80 ° C
- Door type** : Sliding door
- Door Blade (wing)Thickness** : 80 mm
- Door Blade (wing) sheet feature** : Door sheet are coatings with scratch protection surface with PVC films 100-200 μ micron / 0,50 mm x 0,70 mm (minimum) hot dipped galvanized coil coating painted steel.
- Door Blade (wing) sheet quality** : dx51d + z- EN 10327- Standards
- Door Blade (wing) insulation features** : Polyol + Izocsiyanate = Polyurethane
- Insulation density** : 40- 45 kg / m3 - EN 1602 Standards
- Thermal Conductivity Coefficient** : $\lambda = 0,022$ W/mK - EN 13162
- Fire Classification** : PUR- B-s1, d0 EN 13501-1/PIR B-s1, d0 EN 13501-1 (optionally)
- Door Blade (wing) color suggested** : Standard models Ral 9002- Different colors optional
PVDF (Polyvinylidene Floride) Painted Galvanized sheet
- Door Insulation Gaskets** : Double Density Component with Epdm & PVC Combination
Suitable for use in the thermal temperature range between 65 ° C & + 150 ° C As used in food and living areas, it's in compliance with 21.CFR 177.2600 specifications & quality standards . the gasketed U polyamide support are used by us for the first time in the World , it's ensured that the gaskets are 100 % fully pressed against the door sill.
- Door Blade (wing) Case** : DIN 50049-2.2. / EN 10204-3.1.B. Anodized aluminum profile in Polyamide heat bridge according to the unit where the door is used or without bridges Frames first in the world It's implemented by us . this system, even if there is a power failure in the doors where the heater is installed 100% it will be prevented door freezing.
- Door Outer Handle** : There are 2 types of wings (blade) located on the outside of the door which provides a comfortable opening of the doors . According to the dimensions of the door & according to the customer requirements are applied either individually . The large opening lever is made of aluminum & stainless materials. 2. The holding drawbar PA 6.6 (Polyamide 6.6) is produced at 30 % GF standards.
- Door Inner Handle** : In dark rooms , In order to make the door opening handle easier & to facilitate the exit, the phosphor (shiny) marked PVC body has the inner handle with aluminum handle . Two arm application is made according to the door size.
- Door Top Rail (slider) System** : Aluminum top rail for easy opening & closing of doors System is available . Worldwide except Germany & Italy are also working with several companies that are manufacturing in Turkey doors reverse single rail system . While the reverse rail system provides ease of installation , the main purpose is 100% acceptance in terms of work safety rules worldwide . Thanks to this system, the doors do not fall on people in any impact or misuse . Sliding door production system DIN 50049-2.2./EN 10204-3.1.B standards of anodized aluminum profiles are composed of.Gaskets have a special system that can be pressed sideways & above . And it has an aesthetic appearance as it hides the mechanism running on the door . Doors run quietly inside the room No sagging, No breaking.



Door Top Rail Stops : There are L door stops at the top & End of the door to prevent the door from coming off the top rail. It's produced from aluminum profile materials according to DIN 50049-2.2./EN 10204-3.1.B. They are equipped with sound & speed cut-out rubber stop.

Door Top Rail Wheels : ZnAl27Cu2 in accordance with EN 12844 standards Zamak 27 materials are used in heavy industry around the World . Top wheel carriers with double - ball steel ball bearings When we use a plastic material system , we use steel roller bearing , zamak 27 rib rotors & reverse system upper rail wheels consisting of aluminum anodized parts in DIN 50049-2.2./EN 10204-3.1.B standards . You can adjust the irregularities in the units & the floor by means of this system . You can provide the full insulation of your door by completing all the process . To the excellent acoustics , the doors are quiet and easy to open & close.

Door Bottom Rail : DIN 50049-2.2. / EN 10204-3.1.B standards include anodized aluminum coated V sub-rail system . it provides closing of the door with the top + bottom rail system by providing 100% sealing from the bottom . The door lower rail system operates in parallel with the overflow system & the doors are lifted up when the doors are opened + presses down when closing. To this system, insulation is kept at maximum level.

Door Bottom Rail Slider : PVC Appearance PA 6.6 (Polyamide 6.6) is an aesthetic rail slide channel with 30% GF standards . It's mounted 5 cm outwards in the opening direction of the door. It's internal channel , it enables the door bottom rail to open & close easily.

Door Front interlock : Door pre - interlock is produced in male logic with PA 6.6 (Polyamide 6.6) 30% GF standards . It's aesthetic door closers with PVC look . 2- part clamping mechanism 1 piece on the door + 1 part is mounted on the door jamb or closing direction on the unit. Both parts are interlocked in the door closure & 100 % insulation is supported by allowing the door seals to fully press into the moldings.

Door Front frame : Anodized 100% to DIN 50049-2.2./EN 10204-3.1.B Standards german designed against frost , maximum heat insulation polyamide barrier aluminum moldings These frame Door aluminum on the front surface , the frame part inside the unit are PVC frame . It's preferred in units where heat Escape & freezing is desired to be at maximum level.

Door Rear Frame : 2 types of rear frame can be applied according to the wall thickness of the door to be mounted . It has 2 models in aluminum & PVC . Since the rear frames do not carry loads , they are applied only for image aesthetics.

Door Opening System : Sliding doors are mainly operated as manual option . Detailed information on sliding doors as well as motorized sliding doors are in the section.

Resistance (heating cable) : 220 Volt It can be connected directly It can work within the range of- 70 ° C to + 200 ° C Maximum degree.

The viewing Window : Surveillance windows are the window system for viewing the inside & outside . Fiber glass is made of hard & transparent material & Epdm flexible seals 100% leak-proof. (Optional).

Door bumper plate : Aluminum or Pvc Thick absorber materials applied on the inside or outside of the door on the lower parts of the door in frequently used & impacted areas are called bumper . bumpers are available as optional in cold room doors . In addition to aluminum material or PVC plate absorbers, stainless steel 304 quality thick sheet application can be made.



Door Lock

: 100% leak-proof & frost - free door lock that can be locked from the outside . PA 6.6 (Poliamid 6.6) % 30 GF we manufacturing in standards . Dark rooms In order to detect the door lock & facilitate the output , it's marked with phosphorus (bright) (optional)

Optional door accessories

- : Over 30 pieces. colors are Available
- 304 quality chrome stainless sheet blade
- Door Lock
- Viewing window
- Bumper plate
- PIR Polyurethane
- Automatic door closers

ADVANTAGES OF SINGLE WING SLIDING DOORS :

Provides maximum thermal insulation .

It can be opened wider (forklift , truck , truck , container, pallet) provides great convenience in the transition. It provides to prevent heat losses by opening it to the desired extent in periods when big product loading is not done.

- Has an aesthetic & ergonomic look .
- Saves time & space .
- Single wing application saves cost thanks to its functional suitability in required areas.
- One-wing sliding sliding doors provide maximum advantage to the high insulation system , which allows you to use your unit components easily for many years with minimum payment convenience.



Door Bumper Plate Stainless steel 304



Door Bumper Plate PVC

